

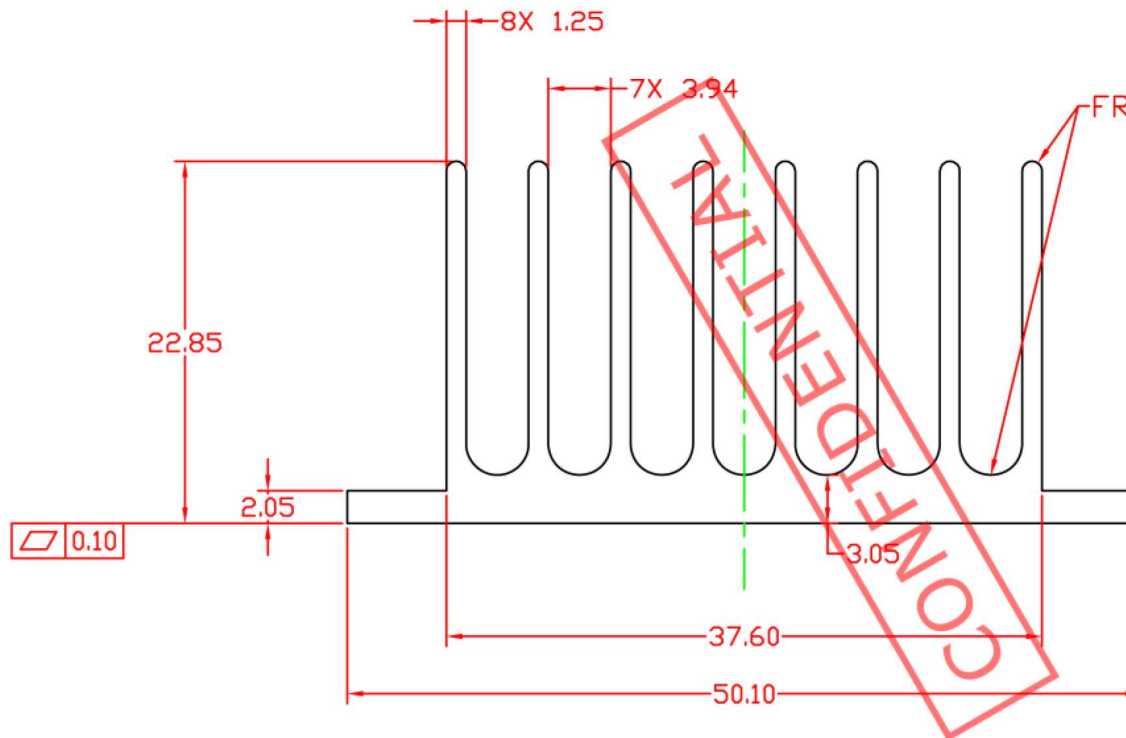

SCALE 1:1



NOTES:

1. THE SECTION AREA = 348.64mm<sup>2</sup>.
2. EXTRUSION WEIGHT : 0.952Kg/m .

TOLERANCES UNLESS NOTED (mm)		CUSTOMER P/N.	Rev.	 <small>Customized Thermal Solution www.alplus.us</small>	
DIMENSION	TOLERANCE	MAT'L:	FINISH:	TITLE:	
X.	±0.60	AL 6063-T5	NONE	HEATSINK EXTRUSION	
X.X	±0.40	CHK :		DWG NO.	Rev.
X.XX	±0.25	DR : Dan NOV/09/2005		E020	A
ANGLES	±1°	SCALE: 2:1		SHEET: 1/1	