

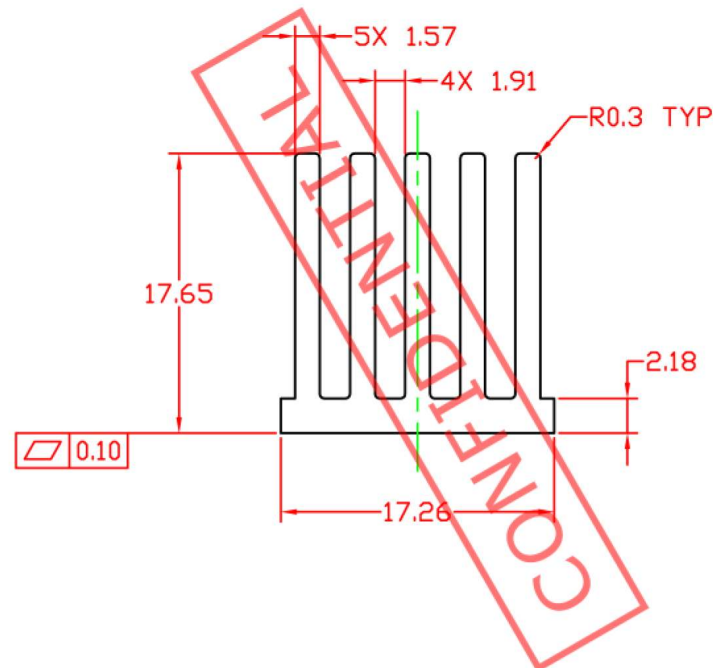

SCALE 1:1



NOTES:

1. THE SECTION AREA = 159.03mm².
2. EXTRUSION WEIGHT : 0.434Kg/m .

TOLERANCES UNLESS NOTED (mm)		CUSTOMER P/N. -	Rev. -	 <small>Customized Thermal Solution www.alplus.us</small>	
DIMENSION	TOLERANCE	MAT'L: AL 6063-T5	FINISH: NONE	TITLE: HEATSINK EXTRUSION	
X.	±0.60	CHK :		DWG NO. E043	Rev. A
X.X	±0.40	DR : Dan NOV/09/2005		SCALE: 2:1	SHEET: 1/1
X.XX	±0.25				
ANGLES	±1°				